



# DIAMOND C-40 Series

## Low Power CO<sub>2</sub> OEM Lasers for Marking and Engraving Applications

The Coherent C-40 CO<sub>2</sub> laser provides 40 Watts of power with best-in-class reliability and package size, making it the OEM laser of choice for high performance laser marking and engraving systems. This production-ready, easy-to-integrate laser system enables high quality laser marking with low maintenance and operating costs. The C-40 is ideal for laser processing of many materials, including paper, plastics, wood, leather, cloth and more.

The C-40 is part of the Coherent C-Series family of products which offer a full range of power levels – from 20W to 70W. Based on a sealed waveguide and inte-grated RF power supply design, the C-40 boasts outstanding production-proven reliability (lifetime >50,000 hours), while delivering superior beam quality and power stability in a compact, flexible and integrated package. The modular platform design provides cost-effective optimization of operating wavelength (from 9.3 to 10.6  $\mu\text{m}$ ) and cooling configuration (air/liquid), enabling rapid adaptability to changing applications and market needs.

### FEATURES

- Versatile power range with high stability and reliability
- Industry leading compact size with integrated RF power supply
- High quality laser processing on a wide range of materials
- Wide power range with constant wave (CW) or pulse width modulation (PWM) control
- Available in multiple wavelength and cooling configurations (air or liquid)

### APPLICATIONS

- Marking
- Engraving
- Cutting

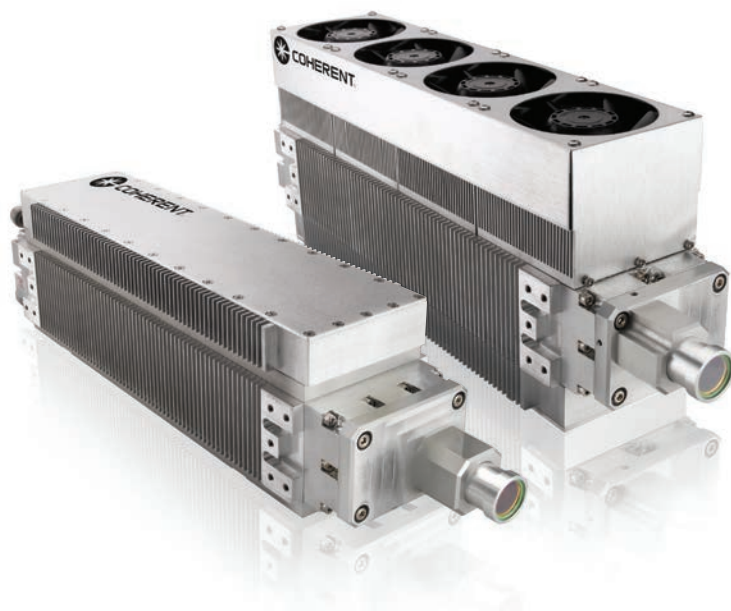

SPECIFICATIONS <sup>1</sup>	DIAMOND C-40A (10.2 μm)	DIAMOND C-40A	DIAMOND C-40L (10.2 μm)	DIAMOND C-40L
Wavelength (μm)	10.11 to 10.31	10.55 to 10.63	10.11 to 10.31	10.55 to 10.63
Optical Output Power <sup>1</sup> (W)	40			
Power Stability <sup>2</sup> (%)	±5			
Mode Quality (M <sup>2</sup> )	<1.3			
Beam Size (mm)	3.6 ±0.5 at output aperture			
Beam Divergence (mrad, full angle)	<5			
Polarization	>100 to 1 (fixed linear, parallel to width dimension)			
Operating Frequency and Duty Cycle	0 to 100 kHz, 0 to 100% DC			
CONFIGURATION AND FACILITY REQUIREMENTS				
Weight	6.8 kg (15.0 lbs.)		6.4 kg (14.0 lbs.)	
Dimensions (L x W x H)	425 x 92.5 x 154.5 mm (16.73 x 3.64 x 6.08 in.)		460.8 x 92.5 x 104.1 mm (18.15 x 3.64 x 4.1 in.) <sup>3</sup>	
Input Power <sup>4</sup>	48 VDC, 13A			
Cooling	Air		Liquid	
Heat Dissipation (W)	<675			
Maximum Case Temperature	<60°C (140°F)			
Operating Environment				
Temperature	5 to 40°C (41 to 113°F)			
Altitude	<2000 m (6500 ft.)			
Humidity	Non-condensing			
Shipping/Storage Environment	-10 to 60°C (14 to 140°F), non-condensing			
Coolant	-		Distilled water with 25 to 35% Dow Frost*	
Coolant Flow Rate	-		>3.8 lpm (1.0 gpm)	
Maximum Coolant Pressure	-		6.9 bar (100 psig)	
Max. Pressure Differential (at 1.0 gpm)	-		1.5 bar (22 psig)	
Coolant Temperature	-		15 to 30°C (59 to 86°F)	

<sup>1</sup> Power measured at 25°C and derated by 1%/C for higher laser head temperatures.

<sup>2</sup> Power stability based on  $\pm(P_{max} - P_{min})/(2*P_{max})$  average power measurement at constant duty cycle after 10-minute warm-up at operating condition.

<sup>3</sup> The overall height dimension is taller for the Dual Chillplate version of this item.

<sup>4</sup> Optional fans add 1A.

\* Dow Frost is a trademark of the Dow Chemical Company.

MECHANICAL SPECIFICATIONS

DIAMOND C-40A  
Laser Head

Top View

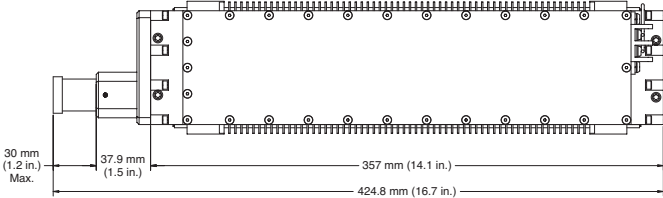

Front View

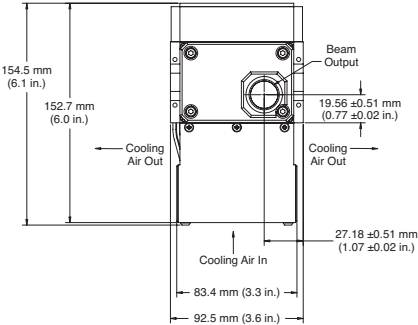

Side View

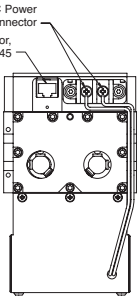
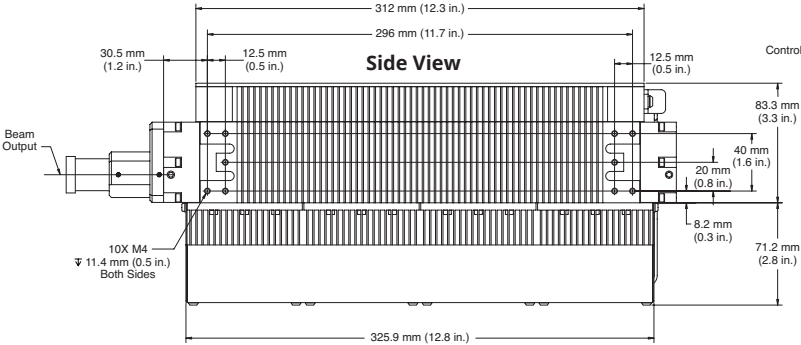

Rear View

Bottom View

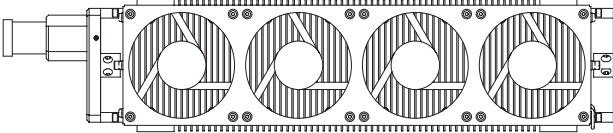

## MECHANICAL SPECIFICATIONS

### DIAMOND C-40L Laser Head

Top View

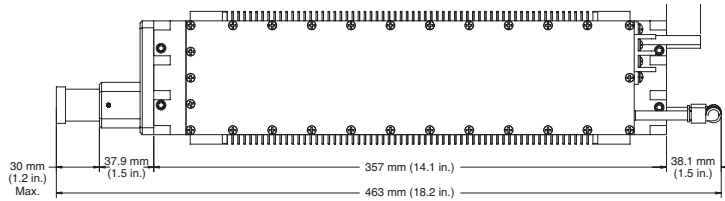

Front View

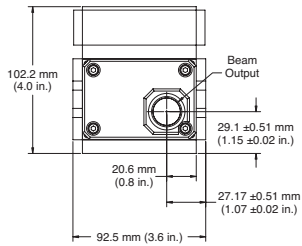

Side View

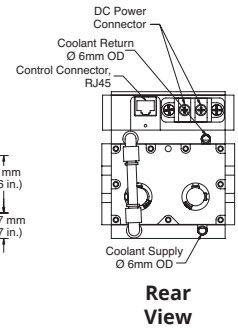
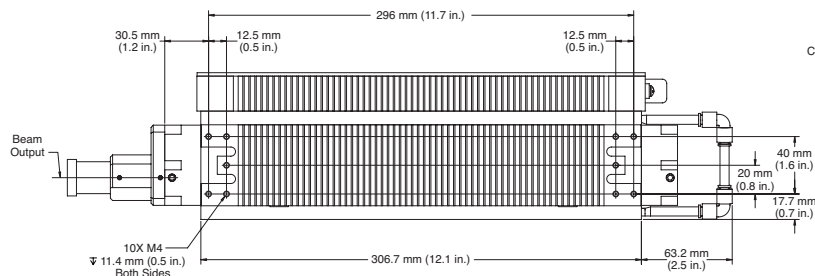

Rear View



Coherent, Inc.,  
5100 Patrick Henry Drive Santa Clara, CA 95054  
p. (800) 527-3786 | (408) 764-4983  
f. (408) 764-4646

[tech.sales@Coherent.com](mailto:tech.sales@Coherent.com) [www.Coherent.com](http://www.Coherent.com)

All specifications subject to change without notice. Coherent, Inc. warrants to the original purchaser for a period of two years from the date of delivery that the DIAMOND J-2 Series product is free from defects in material and workmanship. The warranty does not apply to any unit damaged by accident, abuse or operation in a manner inconsistent with the procedures and specifications outlined in the manual supplied with the laser.

The DIAMOND C-40 CO<sub>2</sub> laser is a component that does not include all safety features as required by the FDA and the Center for Devices and Radiological Health (CDRH). It is sold solely to qualified manufacturers who in their end product will supply all interlocks and indicators, and will comply fully with CDRH regulations and/or local regulatory agencies. Printed in the U.S.A. MC-032-14-0M1117Rev.B Copyright ©2017 Coherent, Inc.

