

OBIS LX/LS

Lasers for Plug-and-Play Simplicity

The Coherent OBIS suite of products offers higher signal-to-noise ratio laser technology for a wide range of applications in the Life Sciences, Environmental Monitoring, and Inspection markets.

Our Optically Pumped Semiconductor Laser (OPSL) technology combined with our laser diode solutions delivers the industry-best laser reliability and performance. The OBIS family of smart lasers covers the wavelength spectrum—from the Ultraviolet at 375 nm to the near-Infrared at 785 nm.

The plug-and-play flexibility allows customers to integrate the product of their choice much faster, thereby reducing their time-to-market and costs.

OBIS LX/LS lasers deliver superior power, low RMS noise, and higher beam quality that are key customer needs from any laser source.

Coherent has implemented an intelligent design that allows multiple ways to interface with the laser, giving our customers the ability to choose the smartest operation process for their specific application requirements.

FEATURES & BENEFITS

- Commonality across the spectrum in dimensions, beam and interface
- Integrated control electronics
- Analog, digital and mixed modulation modes

APPLICATIONS

- Confocal Microscopy
- DNA Sequencing
- Flow Cytometry
- Medical Imaging and Instrumentation



SPECIFICATIONS	OBIS 375LX	OBIS 405LX	OBIS 413LX	OBIS 422LX	OBIS 445LX
Wavelength ¹ (nm)	375	405	413	422	445
Output Power ² (mW)	16, 50	50, 100, 200, 250	100	100	75
Spatial Mode	TEM ₀₀	TEM ₀₀	TEM ₀₀	TEM ₀₀	TEM ₀₀
M ² (Beam Quality) ³	≤1.3	≤1.2 ≤1.3	≤1.2	≤1.2	≤1.2
Beam Asymmetry	≤1:1.2	≤1:1.2	≤1:1.2	≤1:1.2	≤1:1.2
Beam Diameter at 1/e ² (mm)	0.7 ±0.1	0.8 ±0.1	0.8 ±0.1	0.9 ±0.1	0.6 ±0.1
Beam Divergence (mrad, full-angle)	<1	<1	<1	<1.1	<1.1
Pointing Stability (μrad) (over 2 hours after warm-up and ±3°C)	<30	<30	<30	<30	<30
Pointing Stability Over Temp. (μrad/°C)	<5	<5	<5	<5	<5
RMS Noise (%) (20 Hz to 20 MHz)	≤0.05	≤0.05	≤0.05	≤0.05	≤0.05
Peak-to-Peak Noise (%) (20 Hz to 20 kHz)	<0.5	<0.5	<0.5	<0.5	<0.5
Long-term Power Stability (%) (8 hrs., ±3°C)	<2	<2	<2	<2	<2
Warm-up Time ⁴ (minutes) (from cold start)	<5	<5	<5	<5	<5
Polarization Ratio	Minimum 100:1, Vertical ±5°				
Laser Drive Modes	CW, Analog Modulation, Digital Modulation and Computer Control				
Digital Modulation					
Maximum Bandwidth (MHz)	75	150	150	150	150
Rise Time (10% to 90%) (nsec)	<5	<2	<2	<2	<2
Fall Time (90% to 10%) (nsec)	<5	<2	<2	<2	<2
Modulation Depth (extinction ratio)	>1,000,000:1 at 0 Hz, >250:1 at 75 MHz	>1,000,000:1 at 0 Hz, >250:1 at 150 MHz	>1,000,000:1 at 0 Hz, >250:1 at 150 MHz	>1,000,000:1 at 0 Hz, >250:1 at 150 MHz	>1,000,000:1 at 0 Hz, >250:1 at 150 MHz
Analog Modulation					
Maximum Bandwidth (kHz)	500	500	500	500	500
Rise Time (10% to 90%) (nsec)	<700	<700	<700	<700	<700
Fall Time (90% to 10%) (nsec)	<700	<700	<700	<700	<700
Modulation Depth (extinction ratio)	>1,000,000:1	>1,000,000:1	>1,000,000:1	>1,000,000:1	>1,000,000:1
Static Alignment Tolerances					
Beam Position from Reference ⁵ (mm)	<1	<1	<1	<1	<1
Beam Angle ⁵ (mrad)	<5	<5	<5	<5	<5
Beam Waist Position at Exit Window (mm)	n/a	n/a	n/a	n/a	n/a
Laser Safety Classification	3b	3b	3b	3b	3b
ESD Protection	EN61326-1	EN61326-1	EN61326-1	EN61326-1	EN61326-1
Power Consumption (W)	Typical 5, Max. 13	Typical 5, Max. 13	Typical 5, Max. 13	Typical 5, Max. 13	Typical 5, Max. 13
Laser Head Baseplate Temp. (Max., °C)	50	50	50	50	50
Heat Dissipation of Laser Head ⁶ (W)	Typical 5, Max. 13	Typical 5, Max. 13	Typical 5, Max. 13	Typical 5, Max. 13	Typical 5, Max. 13
Ambient Temperature ⁷					
Operating Condition ⁸ (°C)	10 to 50	10 to 50	10 to 50	10 to 50	10 to 50
Non-operating Condition (°C)	-20 to 60	-20 to 60	-20 to 60	-20 to 60	-20 to 60
Shock Tolerance (g) (6 ms)	30	30	30	30	30

¹ Laser-to-laser wavelength tolerance ±2 nm for all OBIS LS versions. For OBIS LX wavelength tolerance of ±5 nm except for 413LX with a 410 nm to 420 nm range; 520LX with a 520 nm to 530 nm range; 640LX with 635 nm to 644 nm range; 660LX with 652 nm to 665 nm range; and 685LX, 730LX, 785LX, 808LX, and 980LX with a ±10 nm range.

² Output power is variable in CW Mode from 1 mW (1% for LX Models) to 110% of rated power. Specifications are valid for 100% power. For LS versions all residual laser emission at 808 nm pump light or fundamental <0.1 mW.

³ For LX versions the M² measured with ModeMaster with 90/10 clip levels.

⁴ For LS versions typical power-on delay 1 minute. For LX versions typical power-on delay 0.1 minutes.

⁵ See mechanical drawing for exit beam location.

⁶ Typically 85% of heat load through the base plate. See Users Manual for more detail.

⁷ Non-Condensing. See User Manual for more detail.

⁸ For LS versions laser head baseplate temperature needs to be maintained at ≤40°C.

SPECIFICATIONS	OBIS 458LX	OBIS 473LX	OBIS 488LX	OBIS 488LS
Wavelength ¹ (nm)	458	473	488	488
Output Power ² (mW)	75	75	50 150	20, 60, 80, 100, 150
Spatial Mode	TEM ₀₀	TEM ₀₀	TEM ₀₀	TEM ₀₀
M ² (Beam Quality) ³	≤1.2	≤1.2	≤1.2	≤1.1
Beam Asymmetry	≤1:1.2	≤1:1.2	≤1:1.2	≤1:1.1
Beam Diameter at 1/e ² (mm)	0.8 ±0.1	0.8 ±0.1	0.8 ±0.1 0.7 ±0.1	0.7 ±0.05
Beam Divergence (mrad, full-angle)	<1.1	<1.1	<1.2	<1.2
Pointing Stability (μrad) (over 2 hours after warm-up and ±3°C)	<30	<30	<30	<30
Pointing Stability Over Temp. (μrad/°C)	<5	<5	<5	<5
RMS Noise (%) (20 Hz to 20 MHz)	≤0.05	≤0.05	≤0.05	≤0.25
Peak-to-Peak Noise (%) (20 Hz to 20 kHz)	<0.5	<0.5	<0.5	<1
Long-term Power Stability (%) (8 hrs., ±3°C)	<2	<2	<2	<2
Warm-up Time ⁴ (minutes) (from cold start)	<5	<5	<5	<5
Polarization Ratio	Minimum 100:1, Vertical ±5°			
Laser Drive Modes	CW, Analog Modulation, Digital Modulation and Computer Control			
Digital Modulation				
Maximum Bandwidth (MHz)	150	150	150	0.05
Rise Time (10% to 90%) (nsec)	<2	<2	<2	<18,000
Fall Time (90% to 10%) (nsec)	<2	<2	<2.5	<2000
Modulation Depth (extinction ratio)	>1,000,000:1 at 0 Hz, >250:1 at 75 MHz	>1,000,000:1 at 0 Hz, >250:1 at 150 MHz	>1,000,000:1 at 0 Hz, >250:1 at 150 MHz	Infinite at 0 Hz to 50 kHz
Analog Modulation				
Maximum Bandwidth (kHz)	500	500	500	100
Rise Time (10% to 90%) (nsec)	<700	<700	<700	<3000
Fall Time (90% to 10%) (nsec)	<700	<700	<700	<3000
Modulation Depth (extinction ratio)	>1,000,000:1	>1,000,000:1	>1,000,000:1	>50:1
Static Alignment Tolerances				
Beam Position from Reference ⁵ (mm)	<1	<1	<1	<0.5
Beam Angle ⁵ (mrad)	<5	<5	<5	<2.5
Beam Waist Position at Exit Window (mm)	n/a	n/a	n/a	±200
Laser Safety Classification	3b	3b	3b	3b
ESD Protection	EN61326-1	EN61326-1	EN61326-1	EN61326-1
Power Consumption (W)	Typical 5, Max. 13	Typical 5, Max. 13	Typical 5, Max. 13	Typical 8, Max. 12
Laser Head Baseplate Temp. (Max., °C)	50	50	50	40
Heat Dissipation of Laser Head ⁶ (W)	Typical 5, Max. 13	Typical 5, Max. 13	Typical 5, Max. 13	Typical 8, Max. 12
Ambient Temperature ⁷				
Operating Condition ⁸ (°C)	10 to 50	10 to 50	10 to 50	15 to 40
Non-operating Condition (°C)	-20 to 60	-20 to 60	-20 to 60	-20 to 60
Shock Tolerance (g) (6 ms)	30	30	30	30

¹ Laser-to-laser wavelength tolerance ±2 nm for all OBIS LS versions. For OBIS LX wavelength tolerance of ±5 nm except for 413LX with a 410 nm to 420 nm range; 520LX with a 520 nm to 530 nm range; 640LX with 635 nm to 644 nm range; 660LX with 652 nm to 665 nm range; and 685LX, 730LX, 785LX, 808LX, and 980LX with a ±10 nm range.

² Output power is variable in CW Mode from 1 mW (1% for LX Models) to 110% of rated power. Specifications are valid for 100% power. For LS versions all residual laser emission at 808 nm pump light or fundamental <0.1 mW.

³ For LX versions the M² measured with ModeMaster with 90/10 clip levels.

⁴ For LS versions typical power-on delay 1 minute. For LX versions typical power-on delay 0.1 minutes.

⁵ See mechanical drawing for exit beam location.

⁶ Typically 85% of heat load through the base plate. See Users Manual for more detail.

⁷ Non-Condensing. See User Manual for more detail.

⁸ For LS versions laser head baseplate temperature needs to be maintained at ≤40°C.

SPECIFICATIONS	OBIS 505LX	OBIS 505LS	OBIS 514LX	OBIS 514LS	OBIS 520LX
Wavelength ¹ (nm)	505	505	514	514	520
Output Power ² (mW)	50	30, 100	40	20, 100, 150	40
Spatial Mode	TEM ₀₀	TEM ₀₀	TEM ₀₀	TEM ₀₀	TEM ₀₀
M ² (Beam Quality) ³	≤1.2	≤1.1	≤1.2	≤1.1	≤1.2
Beam Asymmetry	≤1:1.2	≤1:1.1	≤1:1.2	≤1:1.1	≤1:1.2
Beam Diameter at 1/e ² (mm)	0.7 ±0.1	0.7 ±0.05	0.6 ±0.1	0.7 ±0.05	0.6 ±0.1
Beam Divergence (mrad, full-angle)	<1.2	<1.2	<1.1	<1.2	<1.1
Pointing Stability (μrad) (over 2 hours after warm-up and ±3°C)	<30	<30	<30	<30	<30
Pointing Stability Over Temp. (μrad/°C)	<5	<5	<5	<5	<5
RMS Noise (%) (20 Hz to 20 MHz)	≤0.05	≤0.25	≤0.05	≤0.25	≤0.05
Peak-to-Peak Noise (%) (20 Hz to 20 kHz)	<0.5	<1	<1	<1	<1
Long-term Power Stability (%) (8 hrs., ±3°C)	<2	<2	<2	<2	<2
Warm-up Time ⁴ (minutes) (from cold start)	<5	<5	<5	<5	<5
Polarization Ratio	Minimum 100:1, Vertical ±5°				
Laser Drive Modes	CW, Analog Modulation, Digital Modulation and Computer Control				
Digital Modulation					
Maximum Bandwidth (MHz)	150	0.05	100	0.05	100
Rise Time (10% to 90%) (nsec)	<2	<18,000	<3.5	<18,000	<3.5
Fall Time (90% to 10%) (nsec)	<2.5	<2000	<2	<2000	<2
Modulation Depth (extinction ratio)	>1,000,000:1 at 0 Hz, >250:1 at 150 MHz	Infinite at 0 Hz to 50 kHz	>1,000,000:1 at 0 Hz, >250:1 at 100 MHz	Infinite at 0 Hz to 50 kHz	>1,000,000:1 at 0 Hz, >250:1 at 100 MHz
Analog Modulation					
Maximum Bandwidth (kHz)	500	100	500	100	500
Rise Time (10% to 90%) (nsec)	<700	<3000	<700	<3000	<700
Fall Time (90% to 10%) (nsec)	<700	<3000	<700	<3000	<700
Modulation Depth (extinction ratio)	>1,000,000:1	>50:1	>1,000,000:1	>50:1	>1,000,000:1
Static Alignment Tolerances					
Beam Position from Reference ⁵ (mm)	<1	<0.5	<1	<0.5	<1
Beam Angle ⁵ (mrad)	<5	<2.5	<5	<2.5	<5
Beam Waist Position at Exit Window (mm)	n/a	±200	n/a	±200	n/a
Laser Safety Classification	3b	3b	3b	3b	3b
ESD Protection	EN61326-1	EN61326-1	EN61326-1	EN61326-1	EN61326-1
Power Consumption (W)	Typical 5, Max. 13	Typical 8, Max. 12	Typical 5, Max. 13	Typical 8, Max. 12	Typical 5, Max. 13
Laser Head Baseplate Temp. (Max., °C)	50	40	50	40	50
Heat Dissipation of Laser Head ⁶ (W)	Typical 5, Max. 13	Typical 8, Max. 12	Typical 5, Max. 13	Typical 8, Max. 12	Typical 5, Max. 13
Ambient Temperature ⁷					
Operating Condition ⁸ (°C)	10 to 50	15 to 40	10 to 50	15 to 40	10 to 50
Non-operating Condition (°C)	-20 to 60	-20 to 60	-20 to 60	-20 to 60	-20 to 60
Shock Tolerance (g) (6 ms)	30	30	30	30	30

¹ Laser-to-laser wavelength tolerance ±2 nm for all OBIS LS versions. For OBIS LX wavelength tolerance of ±5 nm except for 413LX with a 410 nm to 420 nm range; 520LX with a 520 nm to 530 nm range; 640LX with 635 nm to 644 nm range; 660LX with 652 nm to 665 nm range; and 685LX, 730LX, 785LX, 808LX, and 980LX with a ±10 nm range.

² Output power is variable in CW Mode from 1 mW (1% for LX Models) to 110% of rated power. Specifications are valid for 100% power. For LS versions all residual laser emission at 808 nm pumplight or fundamental <0.1 mW.

³ For LX versions the M² measured with ModeMaster with 90/10 clip levels.

⁴ For LS versions typical power-on delay 1 minute. For LX versions typical power-on delay 0.1 minutes.

⁵ See mechanical drawing for exit beam location.

⁶ Typically 85% of heat load through the base plate. See Users Manual for more detail.

⁷ Non-Condensing. See User Manual for more detail.

⁸ For LS versions laser head baseplate temperature needs to be maintained at ≤40°C.

SPECIFICATIONS	OBIS 532LS	OBIS 552LS	OBIS 561LS	OBIS 594LS
Wavelength ¹ (nm)	532	552	561	594
Output Power ² (mW)	20, 50, 80, 100, 150	20, 60, 80, 100, 150	20, 50, 80, 100, 150	20, 60, 100
Spatial Mode	TEM ₀₀	TEM ₀₀	TEM ₀₀	TEM ₀₀
M ² (Beam Quality) ³	≤1.1	≤1.1	≤1.1	≤1.1
Beam Asymmetry	≤1:1.1	≤1:1.1	≤1:1.1	≤1:1.1
Beam Diameter at 1/e ² (mm)	0.7 ±0.05	0.7 ±0.05	0.7 ±0.05	0.7 ±0.05
Beam Divergence (mrad, full-angle)	<1.2	<1.2	<1.2	<1.3
Pointing Stability (μrad) (over 2 hours after warm-up and ±3°C)	<30	<30	<30	<30
Pointing Stability Over Temp. (μrad/°C)	<5	<5	<5	<5
RMS Noise (%) (20 Hz to 20 MHz)	≤0.25	≤0.25	≤0.25	≤0.25
Peak-to-Peak Noise (%) (20 Hz to 20 kHz)	<1	<1	<1	<1
Long-term Power Stability (%) (8 hrs., ±3°C)	<2	<2	<2	<2
Warm-up Time ⁴ (minutes) (from cold start)	<5	<5	<5	<5
Polarization Ratio	Minimum 100:1, Vertical ±5°			
Laser Drive Modes	CW, Analog Modulation, Digital Modulation and Computer Control			
Digital Modulation				
Maximum Bandwidth (MHz)	0.05	0.05	0.05	0.05
Rise Time (10% to 90%) (nsec)	<18,000	<18,000	<18,000	<18,000
Fall Time (90% to 10%) (nsec)	<2000	<2000	<2000	<2000
Modulation Depth (extinction ratio)	Infinite at 0 Hz to 50 kHz	Infinite at 0 Hz to 50 kHz	Infinite at 0 Hz to 50 kHz	Infinite at 0 Hz to 50 kHz
Analog Modulation				
Maximum Bandwidth (kHz)	100	100	100	100
Rise Time (10% to 90%) (nsec)	<3000	<3000	<3000	<3000
Fall Time (90% to 10%) (nsec)	<3000	<3000	<3000	<3000
Modulation Depth (extinction ratio)	>50:1	>50:1	>50:1	>50:1
Static Alignment Tolerances				
Beam Position from Reference ⁵ (mm)	<0.5	<0.5	<0.5	<0.5
Beam Angle ⁵ (mrad)	<2.5	<2.5	<2.5	<2.5
Beam Waist Position at Exit Window (mm)	±200	±200	±200	±200
Laser Safety Classification	3b	3b	3b	3b
ESD Protection	EN61326-1	EN61326-1	EN61326-1	EN61326-1
Power Consumption (W)	Typical 8, Max. 12	Typical 8, Max. 12	Typical 8, Max. 12	Typical 8, Max. 12
Laser Head Baseplate Temp. (Max., °C)	40	40	40	40
Heat Dissipation of Laser Head ⁶ (W)	Typical 8, Max. 12	Typical 8, Max. 12	Typical 8, Max. 12	Typical 8, Max. 12
Ambient Temperature ⁷				
Operating Condition ⁸ (°C)	15 to 40	15 to 40	15 to 40	15 to 40
Non-operating Condition (°C)	-20 to 60	-20 to 60	-20 to 60	-20 to 60
Shock Tolerance (g) (6 ms)	30	30	30	30

¹ Laser-to-laser wavelength tolerance ±2 nm for all OBIS LS versions. For OBIS LX wavelength tolerance of ±5 nm except for 413LX with a 410 nm to 420 nm range; 520LX with a 520 nm to 530 nm range; 640LX with 635 nm to 644 nm range; 660LX with 652 nm to 665 nm range; and 685LX, 730LX, 785LX, 808LX, and 980LX with a ±10 nm range.

² Output power is variable in CW Mode from 1 mW (1% for LX Models) to 110% of rated power. Specifications are valid for 100% power. For LS versions all residual laser emission at 808 nm pump/10 or fundamental <0.1 mW.

³ For LX versions the M² measured with ModeMaster with 90/10 clip levels.

⁴ For LS versions typical power-on delay 1 minute. For LX versions typical power-on delay 0.1 minutes.

⁵ See mechanical drawing for exit beam location.

⁶ Typically 85% of heat load through the base plate. See Users Manual for more detail.

⁷ Non-Condensing. See User Manual for more detail.

⁸ For LS versions laser head baseplate temperature needs to be maintained at ≤40°C.

SPECIFICATIONS	OBIS 637LX	OBIS 640LX	OBIS 647LX	OBIS 660LX
Wavelength ¹ (nm)	637	640	647	660
Output Power ² (mW)	140	40, 100	120	100
Spatial Mode	TEM ₀₀	TEM ₀₀	TEM ₀₀	TEM ₀₀
M ² (Beam Quality) ³	≤1.2	≤1.2	≤1.2	≤1.2
Beam Asymmetry	≤1:1.2	≤1:1.2	≤1:1.2	≤1:1.2
Beam Diameter at 1/e ² (mm)	0.7 ±0.1	0.8 ±0.1	0.8 ±0.1	0.9 ±0.1
Beam Divergence (mrad, full-angle)	<1.3	<1.3	<1.3	<1.3
Pointing Stability (μrad) (over 2 hours after warm-up and ±3°C)	<30	<30	<30	<30
Pointing Stability Over Temp. (μrad/°C)	<5	<5	<5	<5
RMS Noise (%) (20 Hz to 20 MHz)	≤0.05	≤0.05	≤0.05	≤0.05
Peak-to-Peak Noise (%) (20 Hz to 20 kHz)	<0.5	<0.5	<0.5	<0.5
Long-term Power Stability (%) (8 hrs., ±3°C)	<2	<2	<2	<2
Warm-up Time ⁴ (minutes) (from cold start)	<5	<5	<5	<5
Polarization Ratio	Minimum 100:1, Vertical ±5°			
Laser Drive Modes	CW, Analog Modulation, Digital Modulation and Computer Control			
Digital Modulation				
Maximum Bandwidth (MHz)	150	150	150	150
Rise Time (10% to 90%) (nsec)	<2	<2	<2	<2
Fall Time (90% to 10%) (nsec)	<2	<2	<2	<2
Modulation Depth (extinction ratio)	>1,000,000:1 at 0 Hz, >250:1 at 150 MHz	>1,000,000:1 at 0 Hz, >250:1 at 150 MHz	>1,000,000:1 at 0 Hz, >250:1 at 150 MHz	>1,000,000:1 at 0 Hz, >250:1 at 150 MHz
Analog Modulation				
Maximum Bandwidth (kHz)	300	500	500	500
Rise Time (10% to 90%) (nsec)	<1200	<700	<700	<700
Fall Time (90% to 10%) (nsec)	<800	<700	<700	<700
Modulation Depth (extinction ratio)	>1,000,000:1	>1,000,000:1	>1,000,000:1	>1,000,000:1
Static Alignment Tolerances				
Beam Position from Reference ⁵ (mm)	<1	<1	<1	<1
Beam Angle ⁵ (mrad)	<5	<5	<5	<5
Beam Waist Position at Exit Window (mm)	n/a	n/a	n/a	n/a
Laser Safety Classification	3b	3b	3b	3b
ESD Protection	EN61326-1	EN61326-1	EN61326-1	EN61326-1
Power Consumption (W)	Typical 5, Max. 13	Typical 5, Max. 13	Typical 5, Max. 13	Typical 5, Max. 13
Laser Head Baseplate Temp. (Max., °C)	50	50	50	50
Heat Dissipation of Laser Head ⁶ (W)	Typical 5, Max. 13	Typical 5, Max. 13	Typical 5, Max. 13	Typical 5, Max. 13
Ambient Temperature ⁷				
Operating Condition ⁸ (°C)	10 to 50	10 to 50	10 to 50	10 to 50
Non-operating Condition (°C)	-20 to 60	-20 to 60	-20 to 60	-20 to 60
Shock Tolerance (g) (6 ms)	30	30	30	30

¹ Laser-to-laser wavelength tolerance ±2 nm for all OBIS LS versions. For OBIS LX wavelength tolerance of ±5 nm except for 413LX with a 410 nm to 420 nm range; 520LX with a 520 nm to 530 nm range; 640LX with 635 nm to 644 nm range; 660LX with 652 nm to 665 nm range; and 685LX, 730LX, 785LX, 808LX, and 980LX with a ±10 nm range.

² Output power is variable in CW Mode from 1 mW (1% for LX Models) to 110% of rated power. Specifications are valid for 100% power. For LS versions all residual laser emission at 808 nm pumplight or fundamental <0.1 mW.

³ For LX versions the M² measured with ModeMaster with 90/10 clip levels.

⁴ For LS versions typical power-on delay 1 minute. For LX versions typical power-on delay 0.1 minutes.

⁵ See mechanical drawing for exit beam location.

⁶ Typically 85% of heat load through the base plate. See Users Manual for more detail.

⁷ Non-Condensing. See User Manual for more detail.

⁸ For LS versions laser head baseplate temperature needs to be maintained at ≤40°C.

SPECIFICATIONS	OBIS 685LX	OBIS 730LX	OBIS 752LX*
Wavelength ¹ (nm)	685	730	752
Output Power ² (mW)	40	30	150
Spatial Mode	TEM ₀₀	TEM ₀₀	TEM ₀₀
M ² (Beam Quality) ³	≤1.2	≤1.2	≤1.2
Beam Asymmetry	≤1:1.2	≤1:1.2	≤1:1.2
Beam Diameter at 1/e ² (mm)	0.8 ±0.1	0.8 ±0.1	0.7 ±0.1
Beam Divergence (mrad, full-angle)	<1.3	<1.3	<1.7
Pointing Stability (μrad) (over 2 hours after warm-up and ±3°C)	<30	<30	<30
Pointing Stability Over Temp. (μrad/°C)	<5	<5	<5
RMS Noise (%) (20 Hz to 20 MHz)	≤0.05	≤0.05	≤0.05
Peak-to-Peak Noise (%) (20 Hz to 20 kHz)	<0.5	<0.5	<0.5
Long-term Power Stability (%) (8 hrs., ±3°C)	<2	<2	<2
Warm-up Time ⁴ (minutes) (from cold start)	<5	<5	<5
Polarization Ratio	Minimum 100:1, Vertical ±5°		
Laser Drive Modes	CW, Analog Modulation, Digital Modulation and Computer Control		
Digital Modulation			
Maximum Bandwidth (MHz)	150	150	150
Rise Time (10% to 90%) (nsec)	<2	<2	<2
Fall Time (90% to 10%) (nsec)	<2	<2	<2
Modulation Depth (extinction ratio)	>1,000,000:1 at 0 Hz, >250:1 at 150 MHz	>1,000,000:1 at 0 Hz, >250:1 at 150 MHz	>1,000,000:1 at 0 Hz, >250:1 at 150 MHz
Analog Modulation			
Maximum Bandwidth (kHz)	500	500	500
Rise Time (10% to 90%) (nsec)	<700	<700	<700
Fall Time (90% to 10%) (nsec)	<700	<700	<700
Modulation Depth (extinction ratio)	>1,000,000:1	>1,000,000:1	>1,000,000:1
Static Alignment Tolerances			
Beam Position from Reference ⁵ (mm)	<1	<1	<1
Beam Angle ⁵ (mrad)	<5	<5	<5
Beam Waist Position at Exit Window (mm)	n/a	n/a	n/a
Laser Safety Classification	3b	3b	3b
ESD Protection	EN61326-1	EN61326-1	EN61326-1
Power Consumption (W)	Typical 5, Max. 13	Typical 5, Max. 13	Typical 5, Max. 13
Laser Head Baseplate Temp. (Max., °C)	50	50	50
Heat Dissipation of Laser Head ⁶ (W)	Typical 5, Max. 13	Typical 5, Max. 13	Typical 5, Max. 13
Ambient Temperature ⁷			
Operating Condition ⁸ (°C)	10 to 50	10 to 50	10 to 50
Non-operating Condition (°C)	-20 to 60	-20 to 60	-20 to 60
Shock Tolerance (g) (6 ms)	30	30	30

¹ Laser-to-laser wavelength tolerance ±2 nm for all OBIS LS versions. For OBIS LX wavelength tolerance of ±5 nm except for 413LX with a 410 nm to 420 nm range; 520LX with a 520 nm to 530 nm range; 640LX with 635 nm to 644 nm range; 660LX with 652 nm to 665 nm range; and 685LX, 730LX, 785LX, 808LX, and 980LX with a ±10 nm range.

² Output power is variable in CW Mode from 1 mW (1% for LX Models) to 110% of rated power. Specifications are valid for 100% power. For LS versions all residual laser emission at 808 nm pump/10 or fundamental <0.1 mW.

³ For LX versions the M² measured with ModeMaster with 90/10 clip levels.

⁴ For LS versions typical power-on delay 1 minute. For LX versions typical power-on delay 0.1 minutes.

⁵ See mechanical drawing for exit beam location.

⁶ Typically 85% of heat load through the base plate. See Users Manual for more detail.

⁷ Non-Condensing. See User Manual for more detail.

⁸ For LS versions laser head baseplate temperature needs to be maintained at ≤40°C.

* Preliminary version.

SPECIFICATIONS	OBIS 785LX	OBIS 808LX	OBIS 980LX
Wavelength ¹ (nm)	785	808	980
Output Power ² (mW)	100	150	100, 150
Spatial Mode	TEM ₀₀	TEM ₀₀	TEM ₀₀
M ² (Beam Quality) ³	≤1.2	≤1.2	≤1.3
Beam Asymmetry	≤1:1.2	≤1:1.2	≤1:1.3
Beam Diameter at 1/e ² (mm)	0.7 ±0.1	0.7 ±0.1	0.7 ±0.1
Beam Divergence (mrad, full-angle)	<1.7	<2.1	<2.8
Pointing Stability (μrad) (over 2 hours after warm-up and ±3°C)	<30	<30	<30
Pointing Stability Over Temp. (μrad/°C)	<5	<5	<5
RMS Noise (%) (20 Hz to 20 MHz)	≤0.05	≤0.05	≤0.05
Peak-to-Peak Noise (%) (20 Hz to 20 kHz)	<0.5	<0.5	<0.5
Long-term Power Stability (%) (8 hrs., ±3°C)	<2	<2	<2
Warm-up Time ⁴ (minutes) (from cold start)	<5	<5	<5
Polarization Ratio	Minimum 100:1, Vertical ±5°	Minimum 50:1, Vertical ±10°	Minimum 100:1, Vertical ±5°
Laser Drive Modes	CW, Analog Modulation, Digital Modulation and Computer Control		
Digital Modulation			
Maximum Bandwidth (MHz)	150	150	150
Rise Time (10% to 90%) (nsec)	<2	<2	<2
Fall Time (90% to 10%) (nsec)	<2	<2	<2
Modulation Depth (extinction ratio)	>1,000,000:1 at 0 Hz, >250:1 at 150 MHz	>1,000,000:1 at 0 Hz, >250:1 at 150 MHz	>1,000,000:1 at 0 Hz, >250:1 at 150 MHz
Analog Modulation			
Maximum Bandwidth (kHz)	500	500	500
Rise Time (10% to 90%) (nsec)	<700	<700	<700
Fall Time (90% to 10%) (nsec)	<700	<700	<700
Modulation Depth (extinction ratio)	>1,000,000:1	>1,000,000:1	>1,000,000:1
Static Alignment Tolerances			
Beam Position from Reference ⁵ (mm)	<1	<1	<1
Beam Angle ⁵ (mrad)	<5	<5	<5
Beam Waist Position at Exit Window (mm)	n/a	n/a	n/a
Laser Safety Classification	3b	3b	3b
ESD Protection	EN61326-1	EN61326-1	EN61326-1
Power Consumption (W)	Typical 5, Max. 13	Typical 5, Max. 13	Typical 5, Max. 13
Laser Head Baseplate Temp. (Max., °C)	50	50	50
Heat Dissipation of Laser Head ⁶ (W)	Typical 5, Max. 13	Typical 5, Max. 13	Typical 5, Max. 13
Ambient Temperature ⁷			
Operating Condition ⁸ (°C)	10 to 50	10 to 50	10 to 50
Non-operating Condition (°C)	-20 to 60	-20 to 60	-20 to 60
Shock Tolerance (g) (6 ms)	30	30	30

¹ Laser-to-laser wavelength tolerance ±2 nm for all OBIS LS versions. For OBIS LX wavelength tolerance of ±5 nm except for 413LX with a 410 nm to 420 nm range; 520LX with a 520 nm to 530 nm range; 640LX with 635 nm to 644 nm range; 660LX with 652 nm to 665 nm range; and 685LX, 730LX, 785LX, 808LX, and 980LX with a ±10 nm range.

² Output power is variable in CW Mode from 1 mW (1% for LX Models) to 110% of rated power. Specifications are valid for 100% power. For LS versions all residual laser emission at 808 nm pump/line or fundamental <0.1 mW.

³ For LX versions the M² measured with ModeMaster with 90/10 clip levels.

⁴ For LS versions typical power-on delay 1 minute. For LX versions typical power-on delay 0.1 minutes.

⁵ See mechanical drawing for exit beam location.

⁶ Typically 85% of heat load through the base plate. See Users Manual for more detail.

⁷ Non-Condensing. See User Manual for more detail.

⁸ For LS versions laser head baseplate temperature needs to be maintained at ≤40°C.

UTILITY AND ENVIRONMENTAL REQUIREMENTS	
Operating Voltage ¹ (VDC)	12 ±2
Dimensions (L x W x H)	
Laser	70 x 40 x 38 mm (2.75 x 1.57 x 1.5 in.)
OBIS Remote (optional)	105 x 68 x 36 mm (4.13 x 2.68 x 1.42 in.)
DC Power Supply (optional)	105 x 42 x 33 mm (4.13 x 1.65 x 1.3 in.)
Cable, Laser to OBIS Remote (optional)	1 m (3.28 ft.) (3 meter and 0.3 meter sold separately)
Weight	
Laser	0.16 kg (0.35 lbs.)
OBIS Remote (optional)	0.24 kg (0.53 lbs.)
DC Power Supply (optional)	0.36 kg (0.79 lbs.)
Cable, Laser to OBIS Remote (optional)	0.1 kg (0.22 lbs.) for 1 meter

¹ If user supplied, the DC power supply has to meet the following requirements: power >20W; ripple <5% peak-to-peak; line regulation <0.5%.

MECHANICAL SPECIFICATIONS

OBIS LX/LS

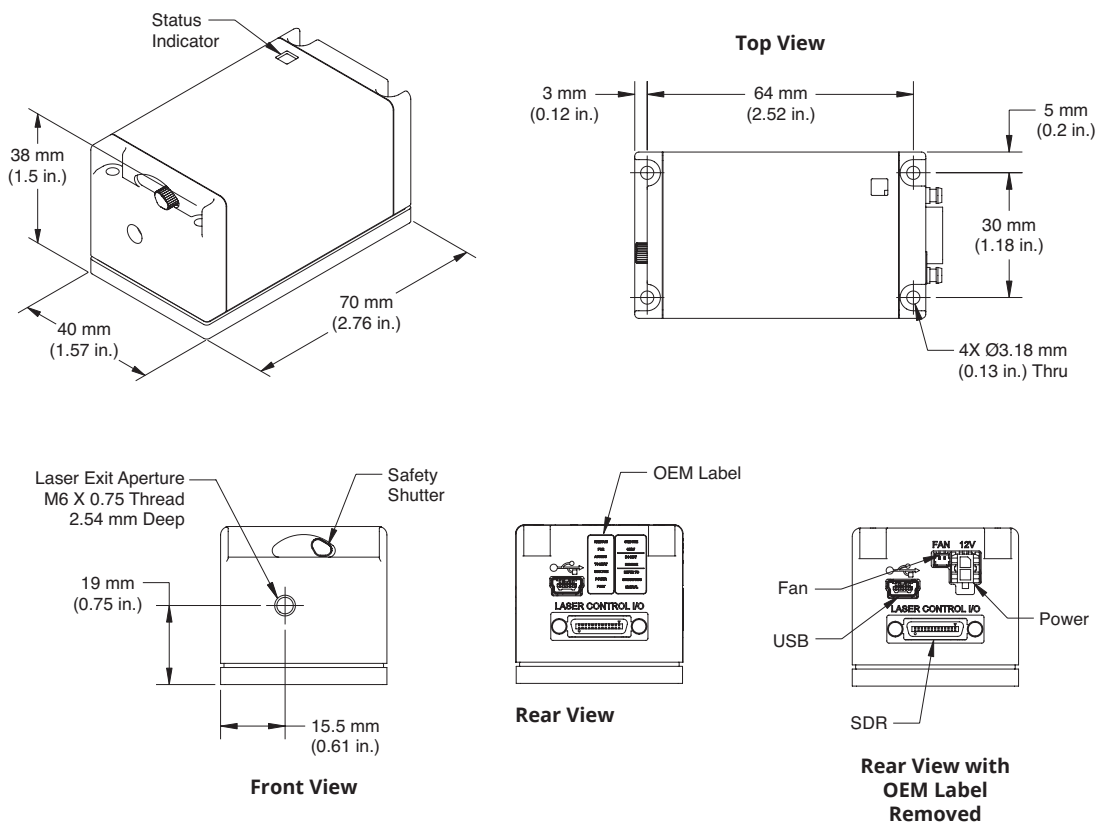

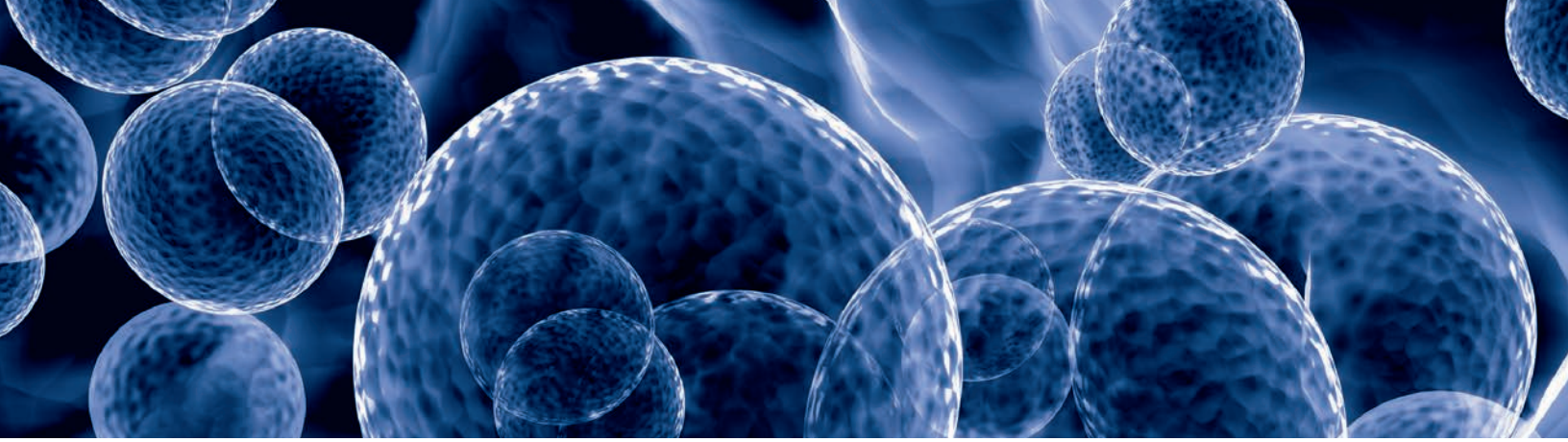

OBIS LX/LS FP

Fiber Pigtailed Lasers in a Plug-and-Play Platform

The OBIS LX/LS Fiber Pigtailed (OBIS FP) suite of lasers delivers the simplicity of a plug-and-play platform for a wide range of wavelengths from the violet to the near IR. The fiber pigtail termination is complete with a FC/APC connector. The OBIS LX/LS FP lasers are based on the OBIS LX/LS laser platform, offering the same speed-to-market benefits.

The OBIS LX/LS FP lasers offer superior performance, reliability, and hands-free operation. These lasers combine single-mode polarization-maintaining fiber with an FC/APC connector for a high-quality low-noise laser beam output. They utilize proprietary fiber technology to provide superior lifetimes, and permanent fiber attachments for guaranteed power over time.

OBIS LX/LS FP lasers are also compatible with MetaMorph and μ Manager Software for microscopy automation and image analysis.



FEATURES & BENEFITS

- All OBIS advantages with fiber delivery
- Single mode, polarization maintaining fiber
- Extended life fiber design

APPLICATIONS

- Confocal Microscopy
- DNA Sequencing
- Flow Cytometry
- Medical Imaging and Instrumentation

SPECIFICATIONS	OBIS FP 405LX	OBIS FP 413LX*	OBIS FP 445LX
Wavelength ¹ (nm)	405	413	445
Output Power ² (mW)	50, 100	50	45
Output from Fiber	FC/APC; 8° angled ⁷	FC/APC; 8° angled ⁷	FC/APC; 8° angled ⁷
Fiber Cable Type	3 mm Mono-Coil	3 mm Mono-Coil	3 mm Mono-Coil
Fiber Cable Length (m) (minimum)	1 (optional 2 m)	1	1
Fiber Numerical Aperture (NA) (1/e ²)	0.05	0.05	0.05
Fiber Core Diameter (μm) (typical)	3.5	3.5	3.5
Spatial Mode	TEM ₀₀	TEM ₀₀	TEM ₀₀
M ² (Beam Quality) ³	≤1.1	≤1.1	≤1.1
Beam Asymmetry	≤1:1.1	≤1:1.1	≤1:1.1
RMS Noise (%) (20 Hz to 20 MHz)	≤0.2	≤0.2	≤0.2
Peak-to-Peak Noise (%) (20 Hz to 20 kHz)	≤2	≤2	≤2
Long-term Power Stability (%) (8 hrs., ±3°C)	<2	<2	<2
Long-term Output Power Average (%/hrs.)	≤5/1000	≤5/1000	≤5/1000
Warm-up Time ⁴ (minutes) (from cold start)	<5	<5	<5
Polarization Ratio	Minimum 100:1	Minimum 100:1	Minimum 100:1
Laser Drive Modes	CW, Analog Modulation, Digital Modulation and Computer Control		
Digital Modulation			
Maximum Bandwidth (MHz)	150	150	150
Rise Time (10% to 90%) (nsec)	<2	<2	<2
Fall Time (90% to 10%) (nsec)	<2	<2	<2
Modulation Depth (extinction ratio)	>1,000,000:1 at 0 Hz, >250:1 at 150 MHz	>1,000,000:1 at 0 Hz, >250:1 at 150 MHz	>1,000,000:1 at 0 Hz, >250:1 at 150 MHz
Analog Modulation			
Maximum Bandwidth (kHz)	500	500	500
Rise Time (10% to 90%) (nsec)	<700	<700	<700
Fall Time (90% to 10%) (nsec)	<700	<700	<700
Modulation Depth (extinction ratio)	>1,000,000:1	>1,000,000:1	>1,000,000:1
Laser Safety Classification	3b	3b	3b
ESD Protection	EN61326-1	EN61326-1	EN61326-1
Power Consumption (W)	Typical 5, Max. 13	Typical 5, Max. 13	Typical 5, Max. 13
Laser Head Baseplate Temperature (Max., °C)	50	50	50
Heat Dissipation of Laser Head ⁵ (W)	Typical 5, Max. 13	Typical 5, Max. 13	Typical 5, Max. 13
Ambient Temperature ⁶			
Operating Condition ⁸ (°C)	10 to 50	10 to 50	10 to 50
Non-operating Condition (°C)	-20 to 60	-20 to 60	-20 to 60
Shock Tolerance (g) (6 ms)	30	30	30

¹ Laser-to-laser wavelength tolerance ±2 nm for all OBIS LS versions. For OBIS LX wavelength tolerance of ±5 nm except for 413LX with a 410 nm to 420 nm range, 520LX with a 520 nm to 530 nm range, 640LX with 635 nm to 644 nm range, 660LX with 652 nm to 665 nm range and 685LX with 675 nm to 695 nm range.

² Output power is variable in CW Mode from 1 mW (1% for LX Models) to 110% of rated power. Specifications are valid for 100% power.

³ M² measured with ModeMaster with 90/10 clip levels.

⁴ Typical power-on delay 0.1 minutes.

⁵ Typically 85% of heat load through the base plate. See Users Manual for more detail.

⁶ Non-Condensing. See User Manual for more detail.

⁷ Fiber FC/APC connector output not compatible for patchcord-to-patchcord connection.

* Preliminary version.

SPECIFICATIONS	OBIS FP 473LX	OBIS FP 488LX	OBIS FP 488LS
Wavelength ¹ (nm)	473	488	488
Output Power ² (mW)	50	30, 100	15 40, 60, 80, 120
Output from Fiber	FC/APC; 8° angled ⁷	FC/APC; 8° angled ⁷	FC/APC; 8° angled FC/APC; 8° angled ⁷
Fiber Cable Type	3 mm Mono-Coil	3 mm Mono-Coil	5 mm Protective Tubing
Fiber Cable Length (m) (minimum)	1	1	0.94
Fiber Numerical Aperture (NA) (1/e ²)	0.05	0.05	0.1 0.06
Fiber Core Diameter (µm) (typical)	3.5	3.5	4
Spatial Mode	TEM ₀₀	TEM ₀₀	TEM ₀₀
M ² (Beam Quality) ³	≤1.1	≤1.1	≤1.1
Beam Asymmetry	≤1:1.1	≤1:1.1	≤1:1.1
RMS Noise (%) (20 Hz to 20 MHz)	≤0.2	≤0.2	≤0.25
Peak-to-Peak Noise (%) (20 Hz to 20 kHz)	≤2	≤2	≤1
Long-term Power Stability (%) (8 hrs., ±3°C)	<2	<2	<2
Long-term Output Power Average (%/hrs.)	≤4/1000	≤4/1000	-
Warm-up Time ⁴ (minutes) (from cold start)	<5	<5	<5
Polarization Ratio	Minimum 100:1	Minimum 100:1	Minimum 100:1
Laser Drive Modes	CW, Analog Modulation, Digital Modulation and Computer Control		
Digital Modulation			
Maximum Bandwidth (MHz)	150	150	0.05
Rise Time (10% to 90%) (nsec)	<2	<2	<18,000
Fall Time (90% to 10%) (nsec)	<2	<2	<2000
Modulation Depth (extinction ratio)	>1,000,000:1 at 0 Hz, >250:1 at 150 MHz	>1,000,000:1 at 0 Hz, >250:1 at 150 MHz	Infinite at 0 Hz to 50 kHz
Analog Modulation			
Maximum Bandwidth (kHz)	500	500	500
Rise Time (10% to 90%) (nsec)	<700	<700	<700
Fall Time (90% to 10%) (nsec)	<700	<700	<700
Modulation Depth (extinction ratio)	>1,000,000:1	>1,000,000:1	>1,000,000:1
Laser Safety Classification	3b	3b	3b
ESD Protection	EN61326-1	EN61326-1	EN61326-1
Power Consumption (W)	Typical 5, Max. 13	Typical 5, Max. 13	Typical 5, Max. 13
Laser Head Baseplate Temperature (Max., °C)	50	50	50
Heat Dissipation of Laser Head ⁵ (W)	Typical 5, Max. 13	Typical 5, Max. 13	Typical 5, Max. 13
Ambient Temperature ⁶			
Operating Condition ⁸ (°C)	10 to 50	10 to 50	10 to 50
Non-operating Condition (°C)	-20 to 60	-20 to 60	-20 to 60
Shock Tolerance (g) (6 ms)	30	30	30

¹ Laser-to-laser wavelength tolerance ±2 nm for all OBIS LS versions. For OBIS LX wavelength tolerance of ±5 nm except for 413LX with a 410 nm to 420 nm range, 520LX with a 520 nm to 530 nm range, 640LX with 635 nm to 644 nm range, 660LX with 652 nm to 665 nm range and 685LX with 675 nm to 695 nm range.

² Output power is variable in CW Mode from 1 mW (1% for LX Models) to 110% of rated power. Specifications are valid for 100% power.

³ M² measured with ModeMaster with 90/10 clip levels.

⁴ Typical power-on delay 0.1 minutes.

⁵ Typically 85% of heat load through the base plate. See Users Manual for more detail.

⁶ Non-Condensing. See User Manual for more detail.

⁷ Fiber FC/APC connector output not compatible for patchcord-to-patchcord connection.

* Preliminary version.

SPECIFICATIONS	OBIS FP 505LX	OBIS FP 514LX	OBIS FP 514LS	OBIS FP 520LX
Wavelength ¹ (nm)	505	514	514	520
Output Power ² (mW)	50	30	15	25
Output from Fiber	FC/APC; 8° angled ⁷	FC/APC; 8° angled ⁷	FC/APC; 8° angled	FC/APC; 8° angled ⁷
Fiber Cable Type	3 mm Mono-Coil	3 mm Mono-Coil	5 mm Protective Tubing	3 mm Mono-Coil
Fiber Cable Length (m) (minimum)	1	1	0.94	1
Fiber Numerical Aperture (NA) (1/e ²)	0.05	0.05	0.1	0.05
Fiber Core Diameter (µm) (typical)	3.5	4.5	4	4.5
Spatial Mode	TEM ₀₀	TEM ₀₀	TEM ₀₀	TEM ₀₀
M ² (Beam Quality) ³	≤1.1	≤1.1	≤1.1	≤1.1
Beam Asymmetry	≤1:1.1	≤1:1.1	≤1:1.1	≤1:1.1
RMS Noise (%) (20 Hz to 20 MHz)	≤0.2	≤0.25	≤0.2	≤0.25
Peak-to-Peak Noise (%) (20 Hz to 20 kHz)	≤2	≤2	≤1	≤2
Long-term Power Stability (%) (8 hrs., ±3°C)	<2	<2	<2	≤2
Long-term Output Power Average (%/hrs.)	≤4/1000	≤3/1000	-	≤3/1000
Warm-up Time ⁴ (minutes) (from cold start)	<5	<5	<5	<5
Polarization Ratio	Minimum 100:1	Minimum 100:1	Minimum 100:1	Minimum 100:1
Laser Drive Modes	CW, Analog Modulation, Digital Modulation and Computer Control			
Digital Modulation				
Maximum Bandwidth (MHz)	150	100	0.05	100
Rise Time (10% to 90%) (nsec)	<2	<3.5	<18,000	<3.5
Fall Time (90% to 10%) (nsec)	<2	<2	<2000	<2
Modulation Depth (extinction ratio)	>1,000,000:1 at 0 Hz, >250:1 at 150 MHz	>1,000,000:1 at 0 Hz, >250:1 at 100 MHz	Infinite at 0 Hz to 50 kHz	>1,000,000:1 at 0 Hz, >250:1 at 100 MHz
Analog Modulation				
Maximum Bandwidth (kHz)	500	500	100	500
Rise Time (10% to 90%) (nsec)	<700	<700	<3000	<700
Fall Time (90% to 10%) (nsec)	<700	<700	<3000	<700
Modulation Depth (extinction ratio)	>1,000,000:1	>1,000,000:1	>50:1	>1,000,000:1
Laser Safety Classification	3b	3b	3b	3b
ESD Protection	EN61326-1	EN61326-1	EN61326-1	EN61326-1
Power Consumption (W)	Typical 5, Max. 13	Typical 5, Max. 13	Typical 8, Max. 12	Typical 5, Max. 13
Laser Head Baseplate Temperature (Max., °C)	50	50	40	50
Heat Dissipation of Laser Head ⁵ (W)	Typical 5, Max. 13	Typical 5, Max. 13	Typical 8, Max. 12	Typical 5, Max. 13
Ambient Temperature ⁶				
Operating Condition ⁸ (°C)	10 to 50	10 to 50	15 to 40	10 to 50
Non-operating Condition (°C)	-20 to 60	-20 to 60	-20 to 60	-20 to 60
Shock Tolerance (g) (6 ms)	30	30	30	30

¹ Laser-to-laser wavelength tolerance ±2 nm for all OBIS LS versions. For OBIS LX wavelength tolerance of ±5 nm except for 413LX with a 410 nm to 420 nm range, 520LX with a 520 nm to 530 nm range, 640LX with 635 nm to 644 nm range, 660LX with 652 nm to 665 nm range and 685LX with 675 nm to 695 nm range.

² Output power is variable in CW Mode from 1 mW (1% for LX Models) to 110% of rated power. Specifications are valid for 100% power.

³ M² measured with ModeMaster with 90/10 clip levels.

⁴ Typical power-on delay 0.1 minutes.

⁵ Typically 85% of heat load through the base plate. See Users Manual for more detail.

⁶ Non-Condensing. See User Manual for more detail.

⁷ Fiber FC/APC connector output not compatible for patchcord-to-patchcord connection.

SPECIFICATIONS	OBIS FP 532LS	OBIS FP 552LS	OBIS FP 561LS	OBIS FP 594LS
Wavelength ¹ (nm)	505	552	561	594
Output Power ² (mW)	20 40, 60, 80, 120	15 40, 60, 80, 120	40, 60, 80, 120	40
Output from Fiber	FC/APC; 8° angled ⁷	FC/APC; 8° angled ⁷	FC/APC; 8° angled ⁷	FC/APC; 8° angled ⁷
Fiber Cable Type	5 mm Protective Tubing	5 mm Protective Tubing	5 mm Protective Tubing	5 mm Protective Tubing
Fiber Cable Length (m) (minimum)	0.94	0.94	0.94	0.94
Fiber Numerical Aperture (NA) (1/e ²)	0.1 0.06	0.1 0.06	0.06	0.06
Fiber Core Diameter (µm) (typical)	4	4	4	4
Spatial Mode	TEM ₀₀	TEM ₀₀	TEM ₀₀	TEM ₀₀
M ² (Beam Quality) ³	≤1.1	≤1.1	≤1.1	≤1.1
Beam Asymmetry	≤1:1.1	≤1:1.1	≤1:1.1	≤1:1.1
RMS Noise (%) (20 Hz to 20 MHz)	≤0.25	≤0.25	≤0.25	≤0.25
Peak-to-Peak Noise (%) (20 Hz to 20 kHz)	≤1	≤1	≤1	≤1
Long-term Power Stability (%) (8 hrs., ±3°C)	<2	<2	<2	≤2
Long-term Output Power Average (%/hrs.)	-	-	-	-
Warm-up Time ⁴ (minutes) (from cold start)	<5	<5	<5	<5
Polarization Ratio	Minimum 100:1	Minimum 100:1	Minimum 100:1	Minimum 100:1
Laser Drive Modes	CW, Analog Modulation, Digital Modulation and Computer Control			
Digital Modulation				
Maximum Bandwidth (MHz)	0.05	0.05	0.05	0.05
Rise Time (10% to 90%) (nsec)	<18,000	<18,000	<18,000	<18,000
Fall Time (90% to 10%) (nsec)	<2000	<2000	<2000	<2000
Modulation Depth (extinction ratio)	Infinite at 0 Hz to 50 kHz	Infinite at 0 Hz to 50 kHz	Infinite at 0 Hz to 50 kHz	Infinite at 0 Hz to 50 kHz
Analog Modulation				
Maximum Bandwidth (kHz)	100	100	100	100
Rise Time (10% to 90%) (nsec)	<3000	<3000	<3000	<3000
Fall Time (90% to 10%) (nsec)	<3000	<3000	<3000	<3000
Modulation Depth (extinction ratio)	>50:1	>50:1	>50:1	>50:1
Laser Safety Classification	3b	3b	3b	3b
ESD Protection	EN61326-1	EN61326-1	EN61326-1	EN61326-1
Power Consumption (W)	Typical 8, Max. 12	Typical 8, Max. 12	Typical 8, Max. 12	Typical 8, Max. 12
Laser Head Baseplate Temperature (Max., °C)	40	40	40	40
Heat Dissipation of Laser Head ⁵ (W)	Typical 8, Max. 12	Typical 8, Max. 12	Typical 8, Max. 12	Typical 8, Max. 12
Ambient Temperature ⁶				
Operating Condition ⁸ (°C)	15 to 40	15 to 40	15 to 40	15 to 40
Non-operating Condition (°C)	-20 to 60	-20 to 60	-20 to 60	-20 to 60
Shock Tolerance (g) (6 ms)	30	30	30	30

¹ Laser-to-laser wavelength tolerance ±2 nm for all OBIS LS versions. For OBIS LX wavelength tolerance of ±5 nm except for 413LX with a 410 nm to 420 nm range, 520LX with a 520 nm to 530 nm range, 640LX with 635 nm to 644 nm range, 660LX with 652 nm to 665 nm range and 685LX with 675 nm to 695 nm range.

² Output power is variable in CW Mode from 1 mW (1% for LX Models) to 110% of rated power. Specifications are valid for 100% power.

³ M² measured with ModeMaster with 90/10 clip levels.

⁴ Typical power-on delay 0.1 minutes.

⁵ Typically 85% of heat load through the base plate. See Users Manual for more detail.

⁶ Non-Condensing. See User Manual for more detail.

⁷ Fiber FC/APC connector output not compatible for patchcord-to-patchcord connection.

SPECIFICATIONS	OBIS FP 637LX	OBIS FP 640LX	OBIS FP 647LX	OBIS FP 660LX
Wavelength ¹ (nm)	637	640	647	660
Output Power ² (mW)	100	75	100	75
Output from Fiber	FC/APC; 8° angled	FC/APC; 8° angled	FC/APC; 8° angled	FC/APC; 8° angled
Fiber Cable Type	3 mm Mono-Coil	3 mm Mono-Coil	3 mm Mono-Coil	3 mm Mono-Coil
Fiber Cable Length (m) (minimum)	1	1	1	1
Fiber Numerical Aperture (NA) (1/e ²)	0.09	0.09	0.09	0.09
Fiber Core Diameter (μm) (typical)	4.5	4.5	4.5	4.5
Spatial Mode	TEM ₀₀	TEM ₀₀	TEM ₀₀	TEM ₀₀
M ² (Beam Quality) ³	≤1.1	≤1.1	≤1.1	≤1.1
Beam Asymmetry	≤1:1.1	≤1:1.1	≤1:1.1	≤1:1.1
RMS Noise (%) (20 Hz to 20 MHz)	≤0.2	≤0.2	≤0.2	≤0.2
Peak-to-Peak Noise (%) (20 Hz to 20 kHz)	≤2	≤2	≤2	≤2
Long-term Power Stability (%) (8 hrs., ±3°C)	<2	<2	<2	≤2
Long-term Output Power Average (%/hrs.)	≤3/1000	≤3/1000	≤3/1000	≤3/1000
Warm-up Time ⁴ (minutes) (from cold start)	<5	<5	<5	<5
Polarization Ratio	Minimum 100:1	Minimum 100:1	Minimum 100:1	Minimum 100:1
Laser Drive Modes	CW, Analog Modulation, Digital Modulation and Computer Control			
Digital Modulation				
Maximum Bandwidth (MHz)	150	150	150	150
Rise Time (10% to 90%) (nsec)	<2	<2	<2	<2
Fall Time (90% to 10%) (nsec)	<2	<2	<2	<2
Modulation Depth (extinction ratio)	>1,000,000:1 at 0 Hz, >250:1 at 150 MHz	>1,000,000:1 at 0 Hz, >250:1 at 150 MHz	>1,000,000:1 at 0 Hz, >250:1 at 150 MHz	>1,000,000:1 at 0 Hz, >250:1 at 150 MHz
Analog Modulation				
Maximum Bandwidth (kHz)	300	500	500	500
Rise Time (10% to 90%) (nsec)	<1200	<700	<700	<700
Fall Time (90% to 10%) (nsec)	<800	<700	<700	<700
Modulation Depth (extinction ratio)	>1,000,000:1	>1,000,000:1	>1,000,000:1	>1,000,000:1
Laser Safety Classification	3b	3b	3b	3b
ESD Protection	EN61326-1	EN61326-1	EN61326-1	EN61326-1
Power Consumption (W)	Typical 5, Max. 13	Typical 5, Max. 13	Typical 5, Max. 13	Typical 5, Max. 13
Laser Head Baseplate Temperature (Max., °C)	50	50	50	50
Heat Dissipation of Laser Head ⁵ (W)	Typical 5, Max. 13	Typical 5, Max. 13	Typical 5, Max. 13	Typical 5, Max. 13
Ambient Temperature ⁶				
Operating Condition ⁸ (°C)	10 to 50	10 to 50	10 to 50	10 to 50
Non-operating Condition (°C)	-20 to 60	-20 to 60	-20 to 60	-20 to 60
Shock Tolerance (g) (6 ms)	30	30	30	30

¹ Laser-to-laser wavelength tolerance ±2 nm for all OBIS LS versions. For OBIS LX wavelength tolerance of ±5 nm except for 413LX with a 410 nm to 420 nm range, 520LX with a 520 nm to 530 nm range, 640LX with 635 nm to 644 nm range, 660LX with 652 nm to 665 nm range and 685LX with 675 nm to 695 nm range.

² Output power is variable in CW Mode from 1 mW (1% for LX Models) to 110% of rated power. Specifications are valid for 100% power.

³ M² measured with ModeMaster with 90/10 clip levels.

⁴ Typical power-on delay 0.1 minutes.

⁵ Typically 85% of heat load through the base plate. See Users Manual for more detail.

⁶ Non-Condensing. See User Manual for more detail.

⁷ Fiber FC/APC connector output not compatible for patchcord-to-patchcord connection.



UTILITY AND ENVIRONMENTAL REQUIREMENTS	
Operating Voltage ¹ (VDC)	12 ±2
Dimensions (L x W x H)	
Laser	70 x 40 x 38 mm (2.75 x 1.57 x 1.5 in.)
OBIS Remote (optional)	105 x 68 x 36 mm (4.13 x 2.68 x 1.42 in.)
DC Power Supply (optional)	105 x 42 x 33 mm (4.13 x 1.65 x 1.3 in.)
Cable, Laser to OBIS Remote (optional)	1 m (3.28 ft.) (3 meter and 0.3 meter sold separately)
Fiber Minimum Bend Radius	51 mm (2.0 in.)
Weight	
Laser	0.23 kg (0.5 lbs.)
OBIS Remote (optional)	0.23 kg (0.5 lbs.)
DC Power Supply (optional)	0.36 kg (0.79 lbs.)
Cable, Laser to OBIS Remote (optional)	0.1 kg (0.22 lbs.) for 1 meter
Fiber Tensile Load (max.)	1 kg (2.2 lbs.)

¹ If user supplied, the DC power supply has to meet the following requirements: power >20W; ripple <5% peak-to-peak; line regulation <0.5%.

MECHANICAL SPECIFICATIONS

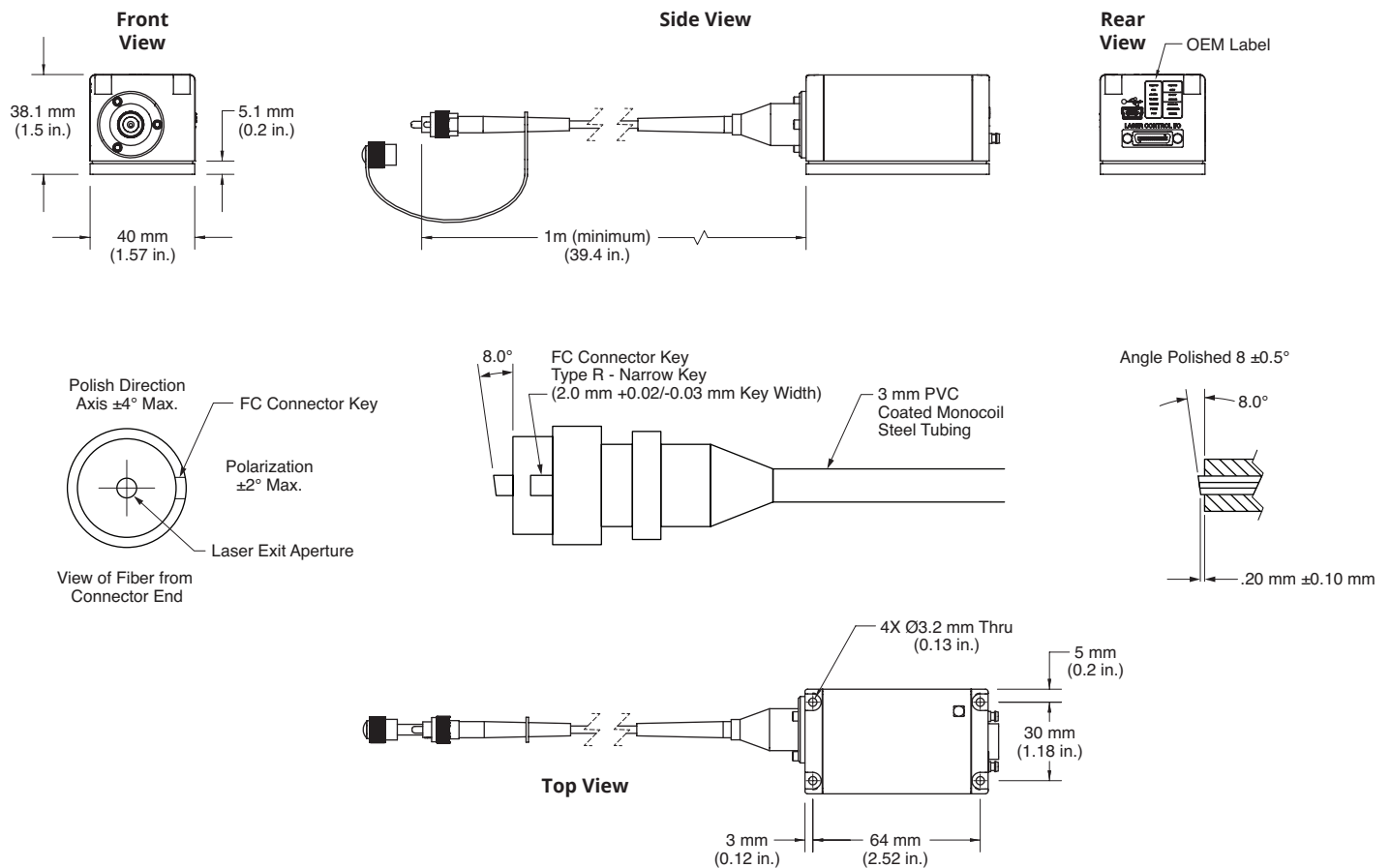
OBIS LX FP

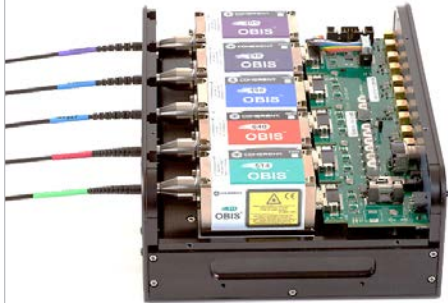

Optional OBIS Laser Remotes	Description
 <p>A compact, black rectangular device with a silver front panel. It features a power knob on the left, several status LEDs (LASER READY, FAIL, REMOTE CONTROL, CAUTION), and a COHERENT logo. A green interlock connector is visible on the right side.</p>	<p>OBIS LX/LS Single Laser Remote with full features for control with analog/digital inputs. Includes USB and RS-232 on the Remote.</p> <p>Part Number 1214875 OBIS LX/LS Single Laser Remote, with Power Supply, 1 meter laser-to-remote (SDR) cable, USB cable and software.</p>
 <p>A compact, black rectangular device with a silver front panel. It features a power knob on the left and six color-coded buttons labeled with wavelengths: 375, 405, 488, 552, 640, and 685. It also has a COHERENT logo and a CAUTION warning.</p>	<p>OBIS LX/LS 6-Laser Remote with CDRH features. Separate power switches and power cables for each laser.</p> <p>Part Number 1203909 OBIS LX/LS 6-Laser Remote, with Power Supply, 6 power cables from laser-to-remote and software.</p>
 <p>A larger, black device with a silver front panel and a built-in touch screen. The screen displays a control interface with various settings and a COHERENT logo. It has multiple ports and a CAUTION warning.</p>	<p>OBIS LX/LS Scientific Remote with full features for control with analog/digital inputs for up to six lasers. User interface touch screen and connectivity through USB, RS-232 and Ethernet.</p> <p>Part Number 1234466 OBIS LX/LS Scientific Remote, with internal Power Supply, 6 laser-to-remote (SDR) cables and software.</p>
 <p>An open black metal chassis containing a green printed circuit board (PCB) with various electronic components. Five laser modules are mounted in bays on the left side, each with a different colored label (purple, blue, red, yellow, green). Cables are connected to the front of the box.</p>	<p>OBIS LX/LS Laser Box with five laser mounting bays with thermal management, cooling fans, analog/digital inputs, RS-232, USB, key-switch and interlock in one compact package. Lasers sold separately.</p> <p>Part Number 1228877 OBIS LX/LS Laser Box, with Power Supply, USB cable and software. Analog Modulation Impedance = 2k Ω, Digital Modulation Impedance = 50 Ω.</p> <p>Part Number 1343229 OBIS LX/LS Laser Box, with Power Supply, USB cable and software. Analog Modulation Impedance = 2k Ω, Digital Modulation Impedance = 2k Ω.</p>

MECHANICAL SPECIFICATIONS

OBIS LS FP

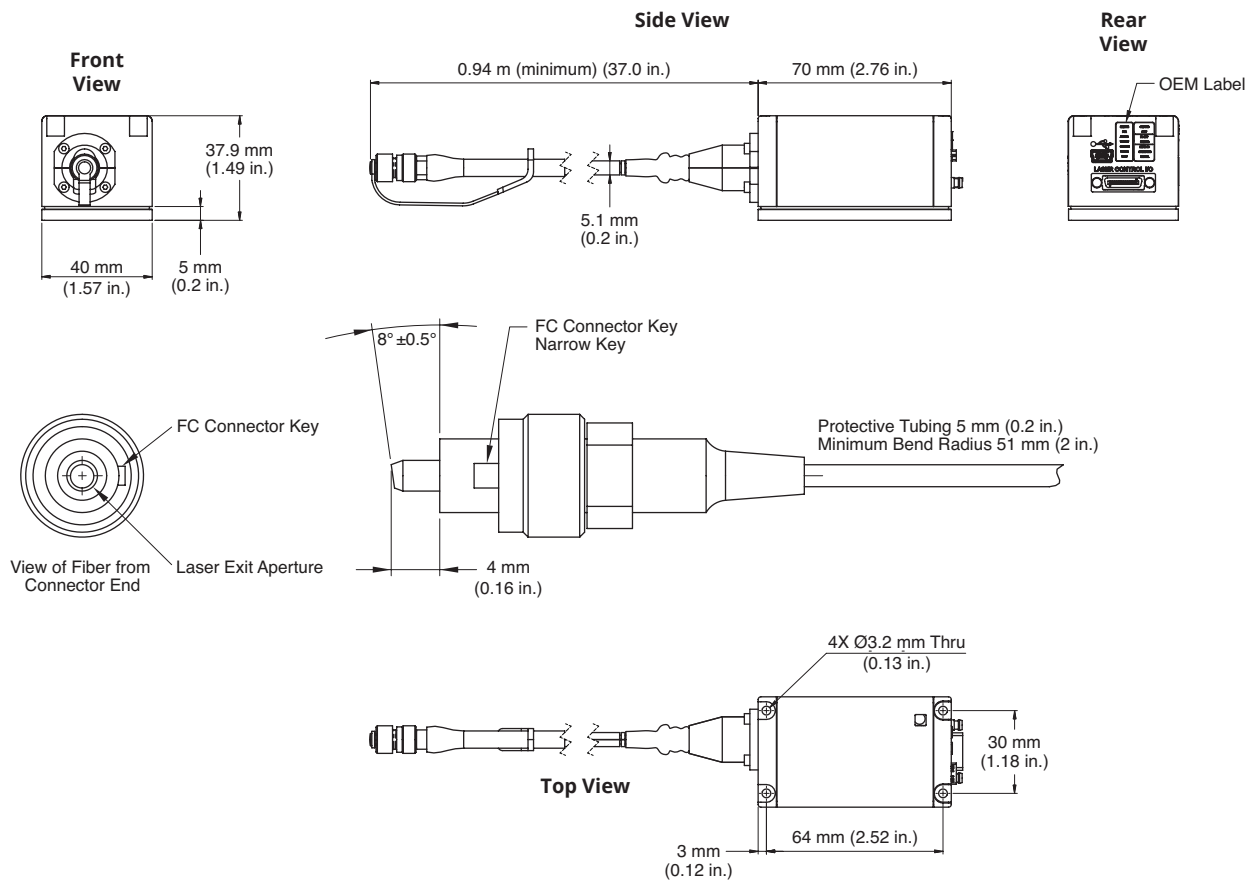

Looking for OBIS Galaxy Lasers? Please refer to the OBIS Galaxy data sheet and/or web page.



Coherent, Inc.,
 5100 Patrick Henry Drive Santa Clara, CA 95054
 p. (800) 527-3786 | (408) 764-4983
 f. (408) 764-4646

tech.sales@coherent.com www.coherent.com

Coherent follows a policy of continuous product improvement. Specifications are subject to change without notice. Coherent's scientific and industrial lasers are certified to comply with the Federal Regulations (21 CFR Subchapter J) as administered by the Center for Devices and Radiological Health on all systems ordered for shipment after August 2, 1976.
 Coherent offers a limited warranty for all OBIS LX/LS Lasers. For full details of this warranty coverage, please refer to the Service section at www.coherent.com or contact your local Sales or Service Representative.
 MC-008-12-0M0818Rev.M Copyright ©2018 Coherent, Inc.

